

# Product datasheet

Specifications



## limit switch XCKP - metal end plunger - 1NC+1NO - snap - M16

Local distributor code: 387028459 XCKP2110P16

### Main

Range of product	Telemecanique Limit switches XC Standard
Series name	Standard format
Product or component type	Limit switch
Device short name	XCKP
Sensor design	Compact form B conforming to CENELEC EN 50047
Body type	Fixed
Head type	Plunger head
Material	Plastic
Body material	Plastic
Head material	Zamak
Fixing mode	By the body
Movement of operating head	Linear
Type of operator	Spring return plunger metal
Type of approach	Vertical approach, 1 direction
Number of poles	2
Contacts type and composition	1 NC + 1 NO
Contact operation	Snap action

### Complementary

Switch actuation	On end
Electrical connection	Screw-clamp terminals, clamping capacity: 1 x 0.34...2 x 1.5 mm <sup>2</sup>
Cable entry	1 entry tapped for M16 x 1.5 cable gland, cable outer diameter: 4...8 mm
Contacts insulation form	Zb
Positive opening	With
Positive opening minimum force	45 N
Minimum force for tripping	15 N
Minimum actuation speed	0.01 m/min
Maximum actuation speed	0.5 m/s
Repeat accuracy	0.1 mm on the tripping points with 1 million operating cycles

<b>Contact code designation</b>	A300, AC-15 (Ue = 240 V), Ie = 3 A, Ithe = 10 A conforming to EN/IEC 60947-5-1 appendix A Q300, DC-13 (Ue = 250 V), Ie = 0.27 A conforming to EN/IEC 60947-5-1 appendix A
<b>[Ui] rated insulation voltage</b>	300 V conforming to UL 508 500 V (pollution degree 3) conforming to IEC 60947-1 300 V conforming to CSA C22.2 No 14
<b>Maximum resistance across terminals</b>	25 MOhm conforming to IEC 60255-7 category 3
<b>[Uimp] rated impulse withstand voltage</b>	6 kV conforming to IEC 60664 6 kV conforming to IEC 60947-1
<b>Short-circuit protection</b>	10 A cartridge fuse, type gG
<b>Electrical durability</b>	5000000 cycles, DC-13, 120 V, 4 W, operating rate <60 cyc/mn, load factor: 0.5 conforming to IEC 60947-5-1 appendix C 5000000 cycles, DC-13, 24 V, 10 W, operating rate <60 cyc/mn, load factor: 0.5 conforming to IEC 60947-5-1 appendix C 5000000 cycles, DC-13, 48 V, 7 W, operating rate <60 cyc/mn, load factor: 0.5 conforming to IEC 60947-5-1 appendix C
<b>Mechanical durability</b>	15000000 cycles
<b>Width</b>	31 mm
<b>Height</b>	65 mm
<b>Depth</b>	30 mm
<b>Net weight</b>	0.09 kg
<b>Terminals description ISO n°1</b>	(13-14)NO (21-22)NC

## Environment

<b>Shock resistance</b>	50 gn for 11 ms conforming to IEC 60068-2-27
<b>Vibration resistance</b>	25 gn (f= 10...500 Hz) conforming to IEC 60068-2-6
<b>IP degree of protection</b>	IP66 conforming to IEC 60529 IP67 conforming to IEC 60529
<b>IK degree of protection</b>	IK04 conforming to EN 50102
<b>Electrical shock protection class</b>	Class II conforming to IEC 61140 Class II conforming to NF C 20-030
<b>Ambient air temperature for operation</b>	-25...70 °C
<b>Ambient air temperature for storage</b>	-40...70 °C
<b>Protective treatment</b>	TC
<b>Product certifications</b>	CCC CSA UL
<b>Standards</b>	EN 60947-5-1 IEC 60204-1 IEC 60947-5-1 CSA C22.2 No 14 UL 508 EN 60204-1

## Packing Units

<b>Unit Type of Package 1</b>	PCE
<b>Number of Units in Package 1</b>	1
<b>Package 1 Weight</b>	72.0 g
<b>Package 1 Height</b>	4.3 cm
<b>Package 1 width</b>	4.6 cm
<b>Package 1 Length</b>	8.1 cm
<b>Unit Type of Package 2</b>	S02

<b>Number of Units in Package 2</b>	81
<b>Package 2 Weight</b>	6.413 kg
<b>Package 2 Height</b>	15 cm
<b>Package 2 width</b>	30 cm
<b>Package 2 Length</b>	40 cm

## Offer Sustainability

<b>Sustainable offer status</b>	Green Premium product
<b>REACH Regulation</b>	<a href="#">REACH Declaration</a>
<b>EU RoHS Directive</b>	Pro-active compliance (Product out of EU RoHS legal scope) <a href="#">EU RoHS Declaration</a>
<b>Mercury free</b>	Yes
<b>RoHS exemption information</b>	<a href="#">Yes</a>
<b>Environmental Disclosure</b>	<a href="#">Product Environmental Profile</a>
<b>Circularity Profile</b>	<a href="#">End of Life Information</a>

## Contractual warranty

<b>Warranty</b>	18 months
-----------------	-----------

Dimensions

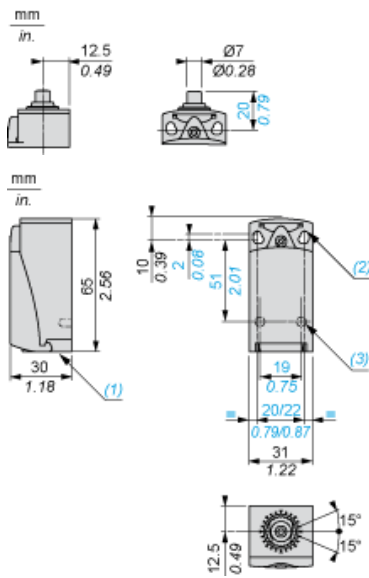

- (1) Tapped entry for M16 x 1.5
- (2) 2 elongated holes Ø 4.3 x 6.3 mm on 22 mm centres, 2 holes Ø 4.3 on 20 mm centres.
- (3) 2 x Ø 3 holes for support studs, depth 4 mm.

**Mounting with Cable Entry**

---

**Position of Cable Gland**

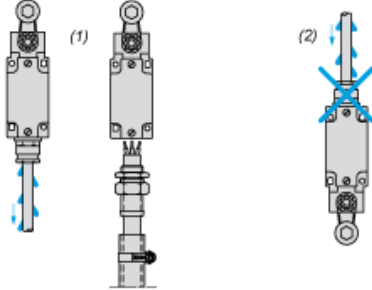

- (1) Recommended
- (2) To be avoided

**Setting-up**

---

**Plunger or Multi-directional Heads**

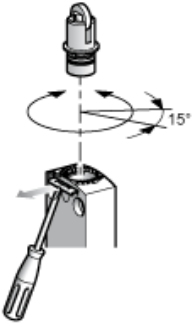

**Wiring Diagram**

---

**2-pole NC + NO Snap Action**

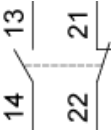

**Characteristics of Actuation**

---

**Switch Actuation on End**

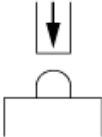



**Functionnal Diagram**

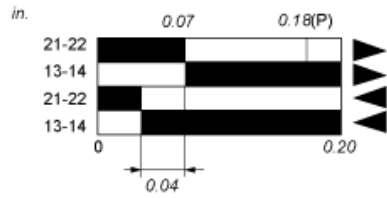
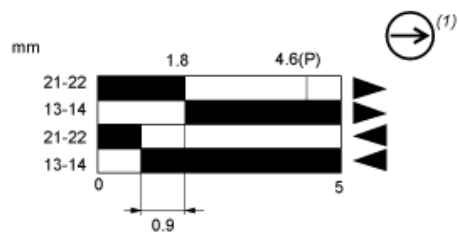

- (2)
- (3)
- (4)
- (5)

- (P) Positive opening point
- (1) NC contact with positive opening operation
- (2) Closed
- (3) Open
- (4) Tripping
- (5) Resetting