

PC T5 PRO Ip, 24 – 80 W

T5 high output, T8 and TC-L fluorescent lamps (CFL)

Product description

- Average life = 50,000 hours (at max ta. with a failure rate $\leq 0.2\%$ per 1,000 hours)
- Large temperature range (for values see table)
- Safety shutdown at end of life
- Automatic start after replacement of defective lamps
- For emergency lighting systems as per EN 50172
- Constant luminous flux irrespective of fluctuations in mains voltage
- For luminaires of protection class 1 and protection class 2
- For luminaires with F or M and MM as per EN 60598, VDE 0710 and VDE 0711
- Insulation Displacement Connection (IDC) terminal for rapid automatic or manual wiring
- Temperature protection as per EN 61347-2-3 C5e

Technical data

AC voltage range	198 – 264 V
DC voltage range	176 – 280 V (Lamp start ≥ 198 V DC)
Overvoltage protection	320 V AC, 1 h
Defined warm start	≤ 1.5 s
Operating frequency	≥ 40 kHz
Type of protection	IP20

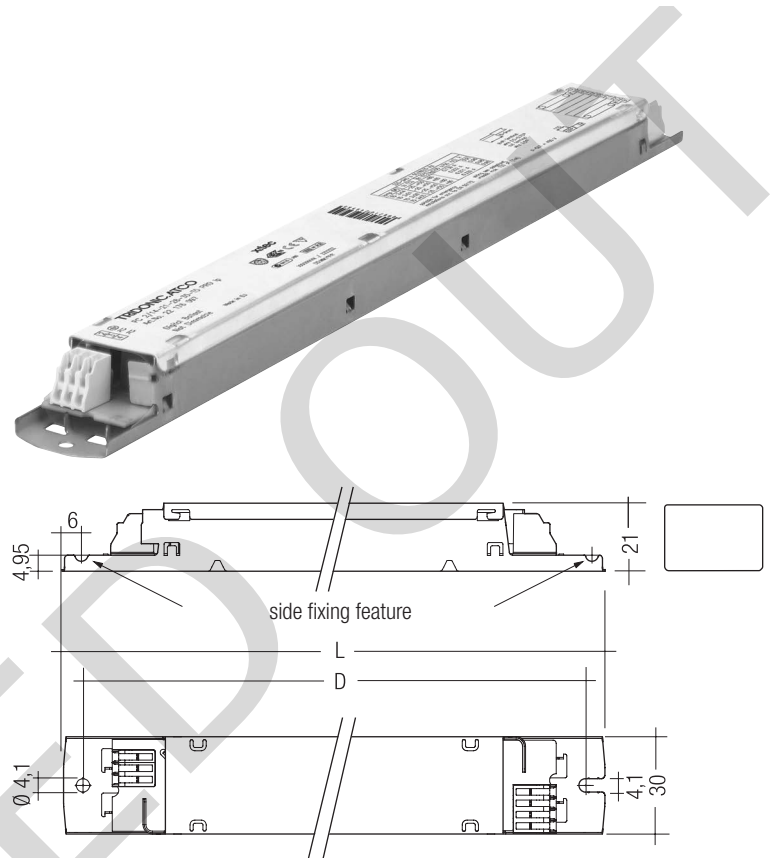

Standards, page 3

Wiring diagrams and installation examples, page 6

Ordering data

Type	Article number
For luminaires with 1 lamp	
PC 1/24 T5 PRO Ip	22176164
PC 1/39 T5 PRO Ip	22176165
PC 1/49 T5 PRO Ip	22176139
PC 1/54 T5 PRO Ip	22176140
PC 1/80 T5 PRO Ip	22176167
For luminaires with 2 lamps	
PC 2/24 T5 PRO Ip	22176168
PC 2/39 T5 PRO Ip	22176166
PC 2/49 T5 PRO Ip	22176099
PC 2/54 T5 PRO Ip	22176100
PC 2/80 T5 PRO Ip	22176234
For luminaires with 3 or 4 lamps	
PC 3/4/24 T5 PRO Ip	22176047

Packaging 280 mm casing: 10 pieces/carton, 960 pieces/pallet

Packaging 360 mm casing: 10 pieces/carton, 760 pieces/pallet

Packaging 425 mm casing: 10 pieces/carton, 640 pieces/pallet

Specific technical data

Lamp wattage	Lamp type	Type	Length L	Hole spacing D	Weight	Lamp wattage	Circuit power	EEI	Current at 50 Hz		λ at 50 Hz		tc point	Ambient temperature ta
									220 V	240 V	220 V	240 V		
For luminaires with 1 lamp														
1 x 24 W	T5	PC 1/24 T5 PRO Ip	280 mm	270 mm	0.18 kg	22.5 W	25.7 W	A2 BAT	0.12 A	0.11 A	0.96	0.95	70 °C	-25 ... 60 °C
1 x 24 W	TC-L	PC 1/24 T5 PRO Ip	280 mm	270 mm	0.18 kg	22.0 W	24.9 W	A2	0.12 A	0.11 A	0.96	0.95	70 °C	-25 ... 60 °C
1 x 39 W	T5	PC 1/39 T5 PRO Ip	280 mm	270 mm	0.18 kg	38.0 W	40.4 W	A2 BAT	0.19 A	0.17 A	0.98	0.97	75 °C	-25 ... 60 °C
1 x 49 W	T5	PC 1/49 T5 PRO Ip	280 mm	270 mm	0.20 kg	49.2 W	52.5 W	A2	0.24 A	0.23 A	0.99	0.97	75 °C	-25 ... 55 °C
1 x 54 W	T5	PC 1/54 T5 PRO Ip	280 mm	270 mm	0.20 kg	54.1 W	57.5 W	A2 BAT	0.26 A	0.25 A	0.99	0.97	70 °C	-25 ... 50 °C
1 x 55 W	TC-L	PC 1/54 T5 PRO Ip	280 mm	270 mm	0.20 kg	55.0 W	59.0 W	A2 BAT	0.26 A	0.24 A	0.98	0.97	70 °C	-25 ... 50 °C
1 x 80 W	T5	PC 1/80 T5 PRO Ip	360 mm	350 mm	0.25 kg	79.8 W	85.8 W	A2	0.40 A	0.36 A	0.99	0.98	75 °C	-25 ... 55 °C
For luminaires with 2 lamps														
2 x 24 W	T5	PC 2/24 T5 PRO Ip	360 mm	350 mm	0.22 kg	45.0 W	48.8 W	A2 BAT	0.23 A	0.21 A	0.98	0.97	70 °C	-25 ... 60 °C
2 x 24 W	TC-L	PC 2/24 T5 PRO Ip	360 mm	350 mm	0.22 kg	44.0 W	48.8 W	A2 BAT	0.23 A	0.21 A	0.98	0.97	70 °C	-25 ... 60 °C
2 x 39 W	T5	PC 2/39 T5 PRO Ip	360 mm	350 mm	0.25 kg	76.0 W	83.4 W	A2 BAT	0.39 A	0.36 A	0.98	0.98	75 °C	-25 ... 55 °C
2 x 49 W	T5	PC 2/49 T5 PRO Ip	360 mm	350 mm	0.26 kg	98.4 W	107.0 W	A2 BAT	0.49 A	0.46 A	0.99	0.97	80 °C	-25 ... 50 °C
2 x 54 W	T5	PC 2/54 T5 PRO Ip	360 mm	350 mm	0.26 kg	108.2 W	114.5 W	A2 BAT	0.53 A	0.49 A	0.99	0.97	80 °C	-25 ... 50 °C
2 x 55 W	TC-L	PC 2/54 T5 PRO Ip	360 mm	350 mm	0.26 kg	108.2 W	114.5 W	A2 BAT	0.53 A	0.49 A	0.99	0.97	80 °C	-25 ... 50 °C
2 x 80 W	T5	PC 2/80 T5 PRO Ip	425 mm	415 mm	0.33 kg	160.0 W	166.6 W	A2 BAT	0.77 A	0.70 A	0.99	0.99	75 °C	-25 ... 55 °C
For luminaires with 3 or 4 lamps														
3 x 24 W	T5	PC 3/4/24 T5 PRO Ip	425 mm	415 mm	0.28 kg	67.5 W	76.0 W	A2 BAT	0.35 A	0.33 A	0.98	0.97	75 °C	-25 ... 55 °C
4 x 24 W	T5	PC 3/4/24 T5 PRO Ip	425 mm	415 mm	0.28 kg	90.0 W	99.0 W	A2 BAT	0.45 A	0.42 A	0.99	0.98	75 °C	-25 ... 50 °C

Standards

EN 55015
EN 61347-2-4
EN 61347-2-3
EN 60929
EN 61000-3-2
EN 61547
according to EN 50172
IEC 60068-2-64 Fh
IEC 60068-2-29 Eb
IEC 60068-2-30

Lamp starting characteristics

Warm start
Starting time 1.5 secs with AC and DC operation
Cathode heating will be reduced after preheat time

AC operation

Mains voltage:
220–240 V 50/60 Hz
198–264 V 50/60 Hz including safety
tolerance ($\pm 10\%$)
202–254 V 50/60 Hz including performance
tolerance ($+6\% / -8\%$)

DC operation

220–240 V 0 Hz
198–280 V 0 Hz certain lamp start
176–280 V 0 Hz operating range
Light output level in DC operation: 100 %

Emergency lighting

Use in emergency lighting installations according to EN 50172 or for emergency luminaires according to EN 61347-2-3 appendix J.

Instant start after mains interruption < 0.5 s

Intelligent Voltage Guard

Intelligent Voltage Guard is the name of the new electronic monitor from Tridonic. This innovative feature of the PC PRO family of control gear from Tridonic immediately shows if the mains voltage rises above or falls below certain thresholds. Measures can then be taken quickly to prevent damage to the control gear.

- If the mains voltage rises above 306 V the lamps start flashing on and off.
- This signal "demands" disconnection of the power supply to the lighting system.
- If the mains voltage falls below 150 V the control gear automatically disconnects the lamp circuit to protect the control gear from being irreparably damaged.

Smart Heating

Innovative heating circuit. Reduced filament heating after lamp ignition.

Mains current in DC operation

Type	Lamp type	Wattage	Mains current at $U_n = 220 V_{DC}$	Mains current at $U_n = 240 V_{DC}$
PC 1/24 T5 PRO Ip	T5	1x24 W	118 mA	108 mA
PC 1/24 T5 PRO Ip	TC-L	1x24 W	114 mA	104 mA
PC 2/24 T5 PRO Ip	T5	2x24 W	224 mA	204 mA
PC 2/24 T5 PRO Ip	TC-L	2x24 W	224 mA	205 mA
PC 3/4/24 T5 PRO Ip	T5	3x24 W	338 mA	310 mA
PC 3/4/24 T5 PRO Ip	T5	4x24 W	446 mA	408 mA
PC 1/39 T5 PRO Ip	T5	1x39 W	186 mA	170 mA
PC 2/39 T5 PRO Ip	T5	2x39 W	382 mA	349 mA
PC 1/49 T5 PRO Ip	T5	1x49 W	239 mA	219 mA
PC 2/49 T5 PRO Ip	T5	2x49 W	486 mA	446 mA
PC 1/54 T5 PRO Ip	T5	1x54 W	261 mA	240 mA
PC 1/54 T5 PRO Ip	TC-L	1x55 W	263 mA	241 mA
PC 2/54 T5 PRO Ip	T5	2x54 W	520 mA	477 mA
PC 2/54 T5 PRO Ip	TC-L	2x55 W	520 mA	477 mA
PC 1/80 T5 PRO Ip	T5	1x80 W	392 mA	359 mA
PC 2/80 T5 PRO Ip	T5	2x80 W	765 mA	701 mA

Harmonic distortion in the mains supply

Type	Lamp type	Wattage	THD at 230 V / 50 Hz
PC 1/24 T5 PRO Ip	T5	1x24 W	$< 10\%$
PC 1/24 T5 PRO Ip	TC-L	1x24 W	$< 10\%$
PC 2/24 T5 PRO Ip	T5	2x24 W	$< 10\%$
PC 2/24 T5 PRO Ip	TC-L	2x24 W	$< 10\%$
PC 3/4/24 T5 PRO Ip	T5	3x24 W	$< 10\%$
PC 3/4/24 T5 PRO Ip	T5	4x24 W	$< 10\%$
PC 1/39 T5 PRO Ip	T5	1x39 W	$< 10\%$
PC 2/39 T5 PRO Ip	T5	2x39 W	$< 10\%$
PC 1/49 T5 PRO Ip	T5	1x49 W	$< 10\%$
PC 2/49 T5 PRO Ip	T5	2x49 W	$< 10\%$
PC 1/54 T5 PRO Ip	T5	1x54 W	$< 10\%$
PC 1/54 T5 PRO Ip	TC-L	1x55 W	$< 10\%$
PC 2/54 T5 PRO Ip	T5	2x54 W	$< 10\%$
PC 2/54 T5 PRO Ip	TC-L	2x55 W	$< 10\%$
PC 1/80 T5 PRO Ip	T5	1x80 W	$< 10\%$
PC 2/80 T5 PRO Ip	T5	2x80 W	$< 10\%$

Output voltage

Type	Lamp type	Wattage	U_{out}
PC 1/24 T5 PRO Ip	T5	1x24 W	250 V
PC 1/24 T5 PRO Ip	TC-L	1x24 W	250 V
PC 2/24 T5 PRO Ip	T5	2x24 W	250 V
PC 2/24 T5 PRO Ip	TC-L	2x24 W	250 V
PC 3/4/24 T5 PRO Ip	T5	3x24 W	350 V
PC 3/4/24 T5 PRO Ip	T5	4x24 W	350 V
PC 1/39 T5 PRO Ip	T5	1x39 W	250 V
PC 2/39 T5 PRO Ip	T5	2x39 W	250 V
PC 1/49 T5 PRO Ip	T5	1x49 W	300 V
PC 2/49 T5 PRO Ip	T5	2x49 W	300 V
PC 1/54 T5 PRO Ip	T5	1x54 W	250 V
PC 1/54 T5 PRO Ip	TC-L	1x55 W	250 V
PC 2/54 T5 PRO Ip	T5	2x54 W	350 V
PC 2/54 T5 PRO Ip	TC-L	2x55 W	350 V
PC 1/80 T5 PRO Ip	T5	1x80 W	300 V
PC 2/80 T5 PRO Ip	T5	2x80 W	400 V

Ballast lumen factor (EN 60929 8.1)

Type	Lamp type	Wattage	AC/DC-BLF at U = 198–254 V, 25 °C
PC 1/24 T5 PRO Ip	T5	1x24 W	1,00
PC 1/24 T5 PRO Ip	TC-L	1x24 W	1,00
PC 2/24 T5 PRO Ip	T5	2x24 W	1,00
PC 2/24 T5 PRO Ip	TC-L	2x24 W	1,00
PC 3/4/24 T5 PRO Ip	T5	3x24 W	1,03
PC 3/4/24 T5 PRO Ip	T5	4x24 W	1,07
PC 1/39 T5 PRO Ip	T5	1x39 W	1,00
PC 2/39 T5 PRO Ip	T5	2x39 W	1,00
PC 1/49 T5 PRO Ip	T5	1x49 W	1,00
PC 2/49 T5 PRO Ip	T5	2x49 W	1,00
PC 1/54 T5 PRO Ip	T5	1x54 W	1,00
PC 1/54 T5 PRO Ip	TC-L	1x55 W	1,00
PC 2/54 T5 PRO Ip	T5	2x54 W	1,00
PC 2/54 T5 PRO Ip	TC-L	2x55 W	0,95
PC 1/80 T5 PRO Ip	T5	1x80 W	1,00
PC 2/80 T5 PRO Ip	T5	2x80 W	1,00

PC PRO with xitec processor

Is the very latest in lighting management design technology. The lamp friendly warm start is delivering maximum lamp life and enables high switching frequency applications. Smallest power loss and new freedom in the lamp design thanks to convincing thermal management.

Energy class CELMA EEI = A2 / A2 BAT¹⁾

PC T5 PRO Ip ignition technology (smart heating) optimises lamp start and ensures no energy is wasted. After the lamp has struck the filament heating is reduced automatically to a defined minimum value. This reduction in filament heating, saves energy, yet maintains the proper operating conditions for the lamp. The lamp is always operated within specification.

¹⁾ according to the EU directives on ecodesign requirements (EC) No. 245/2009 and (EC) No. 347/2010

Temperature range

PC 1/24–54 T5 PRO Ip

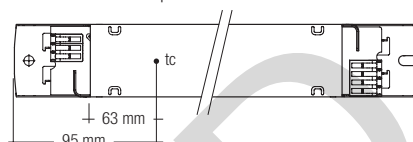

PC 2/24–54 T5 PRO Ip

PC 1/80 T5 PRO Ip

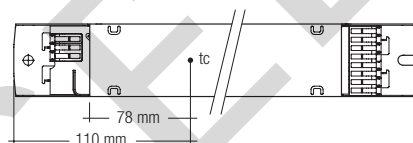

PC 2/80 T5 PRO Ip

PC 3/4/24 T5 PRO Ip

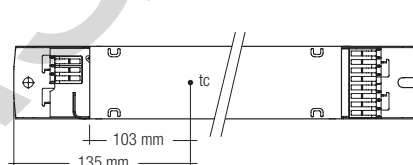

The nominal t_a and t_c point are related to the ballast life duration.

The relation of t_c to t_a temperature depends also on the luminaire design. If the measured t_c temperature is approx. 5 K below t_c max., t_a temperature should be checked and eventually critical components (e.g. ELCAP) measured. Detailed information on request.

PC T5 PRO Ip is designed for an average service life of 50,000 hours under reference conditions and with a failure probability of less than 10 %. This corresponds to an average failure rate of 0.2 % for every 1,000 hours of operation.

Humidity: 5 % up to max. 85 %, not condensed (max. 56 days/year at 85 %)

Storage temperature: -40 °C up to max. +80 °C

The devices have to be within the specified temperature range (t_a) before they can be operated.

Loading of automatic circuit breakers

Automatic circuit breaker type	C10	C13	C16	C20	B10	B13	B16	B20
Installation Ø	1.5 mm ²	1.5 mm ²	1.5 mm ²	2.5 mm ²	1.5 mm ²	1.5 mm ²	1.5 mm ²	2.5 mm ²
PC 1/24 T5 PRO Ip	28	40	44	58	14	20	22	29
PC 2/24 T5 PRO Ip	28	40	44	58	14	20	22	29
PC 3/4/24 T5 PRO Ip	14	18	22	28	7	9	11	14
PC 1/39 T5 PRO Ip	28	40	44	58	14	20	22	29
PC 2/39 T5 PRO Ip	18	28	30	36	9	14	15	18
PC 1/49 T5 PRO Ip	28	40	44	58	14	20	22	29
PC 1/54 T5 PRO Ip	28	40	44	58	14	20	22	29
PC 2/49 T5 PRO Ip	18	28	30	36	9	14	15	18
PC 2/54 T5 PRO Ip	14	20	24	30	7	10	12	15
PC 1/80 T5 PRO Ip	18	28	30	36	9	14	15	18
PC 2/80 T5 PRO Ip	10	14	16	20	5	7	8	10

Wiring advice

The lead length is dependant on the capacitance of the cable.

For safety reasons, the PC T5 PRO Ip must only be earthed in the case of a safety class 1 luminaire. Earthing is not required for the device to operate. Connection to earth reduces radio interference.

With standard solid wire 0.5/0.75 mm² the capacitance of the lead is 30–80 pF/m. This value is influenced by the way the wiring is made.

- keep lamp wires short
- lamp connection should be made with symmetrical wiring
- hot leads 9, 10, 15, 16 and cold leads 11, 12, 13, 14 should be separated as much as possible

Ballast Type	Terminal	Maximum capacitance allowed			
		Cold		Hot	
PC 1/xx T5 PRO Ip		11, 12	9, 10	200 pF	100 pF
PC 2/xx T5 PRO Ip		11, 12, 13, 14	9, 10, 15, 16	200 pF	100 pF
PC 3/4/24 T5 PRO Ip		5, 6, 7, 8, 11, 14	9, 10, 15, 16	200 pF	100 pF

To avoid the damage of the control gear, the wiring must be protected against short circuits to earth (sharp edged metal parts, metal cable clips, louver, etc.)

Installation instructions

IDC interface

- solid wire with a cross section of 0.5 mm² according to the specification from WAGO

Horizontal interface

- solid wire with a cross section of 0.5–0.75 mm² according to the specification from WAGO
- solid wire with a cross section of 1.0 mm² with an insulation diameter up to 2.5 mm
- strip 9 mm of insulation from the cables to ensure perfect operation of the push terminals
- Loosen wire through twisting and pulling

wire preparation:
0.5 – 0.75 mm²

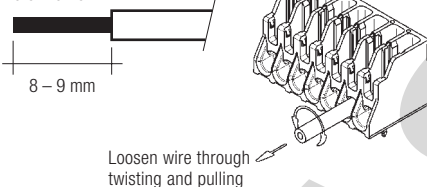

Loosen wire through
twisting and pulling

Side fixing feature

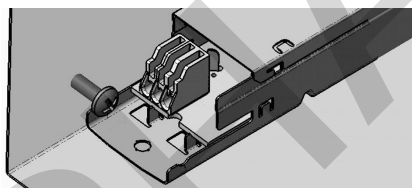

Screw M4, screw head diameter 8–10 mm

Defective lamp

If a lamp is defective, the ballast switches off and goes into standby. There is an automatic restart once the lamp has been changed.

T5 High Output (FO)

	wattage	length
	24 W	549 mm
	39 W	849 mm
	49 W	1449 mm
	54 W	1149 mm
	80 W	1449 mm

RFI

Tridonic ballasts are RFI protected in accordance with EN 55015.

To operate the luminaire correctly and to minimise RFI we recommend the following instructions:

- Connection to the lamps of the “hot leads” must be kept as short as possible (marked with *)
- Mains leads should be kept apart from lamp leads (ideally 5–10 cm distance)
- Do not run mains leads adjacent to the electronic ballast
- Twist the lamp leads
- Keep the distance of lamp leads from the metal work as large as possible
- Ballast must be earthed, either over the terminal or over the mounting screw of the ballast
- Mains wiring to be twisted when through wiring
- Keep the mains leads inside the luminaire as short as possible

Isolation and electric strength testing of luminaires

Electronic devices can be damaged by high voltage. This has to be considered during the routine testing of the luminaires in production.

According to IEC 60598-1 Annex Q (informative only!) or ENEC 303-Annex A, each luminaire should be submitted to an isolation test with 500 V_{DC} for 1 second. This test voltage should be connected between the interconnected phase and neutral terminals and the earth terminal.

The isolation resistance must be at least 2 MΩ.

As an alternative, IEC 60598-1 Annex Q describes a test of the electrical strength with 1500 V_{AC} (or 1.414 x 1500 V_{DC}). To avoid damage to the electronic devices this test must not be conducted.

Additional information

Additional technical information at www.tridonic.com → Technical Data

Guarantee conditions at www.tridonic.com → Services

No warranty if device was opened.

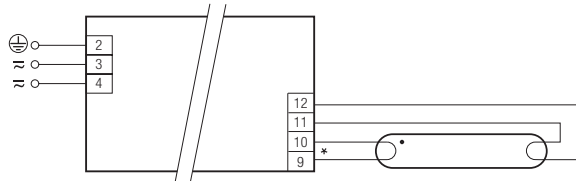

* leads 9, 10 max. 1.0 m (< 100 pF)
leads 11, 12 max. 2.0 m (< 200 pF)
Protection class I - luminaires: earth of ballast housing or ground terminal required (according to IEC 60598)
Protection class II - luminaires: no earth required

PC 1/24-80 T5 PRO Ip

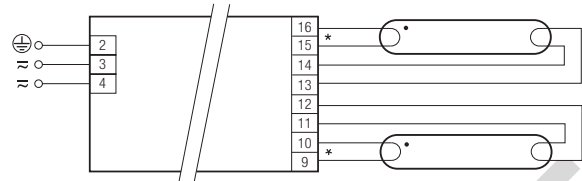

* leads 9, 10, 15, 16 max. 1.0 m (< 100 pF)
leads 11, 12, 13, 14 max. 2.0 m (< 200 pF)
Protection class I - luminaires: earth of ballast housing or ground terminal required (according to IEC 60598)
Protection class II - luminaires: no earth required

PC 2/24-80 T5 PRO Ip

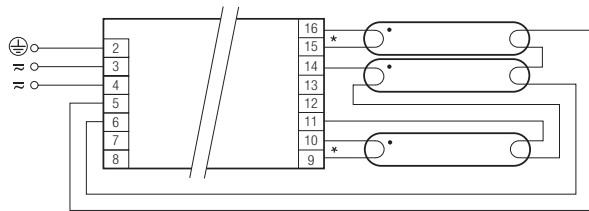

* leads 9, 10, 15, 16 max. 1.0 m (< 100 pF)
leads 5, 6, 7, 8, 11, 14 max. 2.0 m (< 200 pF)
Protection class I - luminaires: earth of ballast housing or ground terminal required (according to IEC 60598)
Protection class II - luminaires: no earth required

PC 3/24 T5 PRO Ip

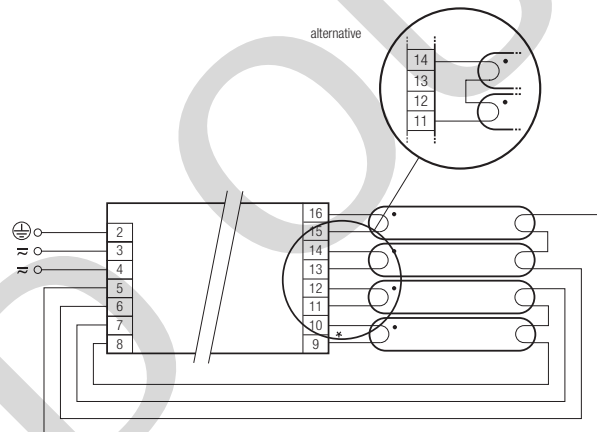

* leads 9, 10 max. 1.0 m (< 100 pF)
leads 5, 6, 7, 8, 11, 12, 13, 14, 15, 16 max. 2.0 m (< 200 pF)
Protection class I - luminaires: earth of ballast housing or ground terminal required (according to IEC 60598)
Protection class II - luminaires: no earth required

PC 4/24 T5 PRO Ip