

EMSKV 25

Cable gland, brass nickel-plated, M25, with short thread

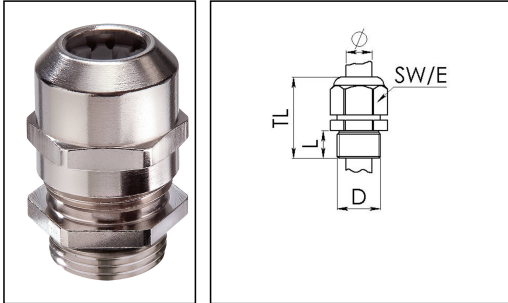

Products may differ in size, colour and appearance to those shown. If you require further information or customisation, please contact us directly.



Material cable gland	Brass nickel-plated
Material clamping cage	Polyamide
Material sealing gasket	EPDM
Temp. range min	-40 °C
Temp. range max	100 °C
Protection class	IP68 (5 bar 30 min), IP69
Thread type	M
Ø Connection thread D	25
Lead	1,5
Length screw-in thread L	7 mm
Ø cable diameter min	9 mm
Ø cable diameter max	17 mm
Ø cable diameter UL	10,8 mm - 15,8 mm
Key width SW	29 mm
Collar diameter (E)	32 mm
Total length TL	33 mm - 42 mm
Type of cable anchorage	A
Install. torques fitting	10 N m
Install. torques cap nut	10 N m
Impact category	6
Surface	Nickel-plated
Order no. nickel-plated	10065003
Packing unit	50
Type	EMSKV 25
ETIM-Classification	EC000441

Your Contact:

WISKA Hoppmann GmbH

Kisdorfer Weg 28 · 24568 Kaltenkirchen · Germany

☎ +49-4191-508-0 · 📠 +49-4191-508-209

contact@wiska.de · www.wiska.com

Recommended accessories

MFD 25/02/060	10060452
RDE 25	10060768
MFD 25/02/080	10060952
MFD 25/01/065	10060954
EMMU 25	10063144
MFD 25/02/070	10063995
BS 17	10064012
MFD 25/03/070	10064342
MFD 25/04/060	10064343
MFD 25/01/090	10101016
MFD 25/01/105-01/055	10101255
MFD 25/05/056	10102023

25.08.2020

Your Contact:

WISKA Hoppmann GmbH

Kisdorfer Weg 28 · 24568 Kaltenkirchen · Germany

 +49-4191-508-0 ·  +49-4191-508-209

contact@wiska.de · www.wiska.com



Your Contact:

WISKA Hoppmann GmbH

Kisdorfer Weg 28 · 24568 Kaltenkirchen · Germany

☎ +49-4191-508-0 · 📠 +49-4191-508-209

contact@wiska.de · www.wiska.com